

# High Performance BGA Cooling Solutions w/ Thermal Tape Attachment\*

DIGI-KEY PART # **ATS1218-ND**

ATS PART # ATS-54270K-C2-R0

## Features & Benefits

High aspect ratio, straight fin heat sinks that are ideal for compact PCB environments

Designed specifically for BGAs and other surface mount packages

Comes preassembled with high performance thermal interface material

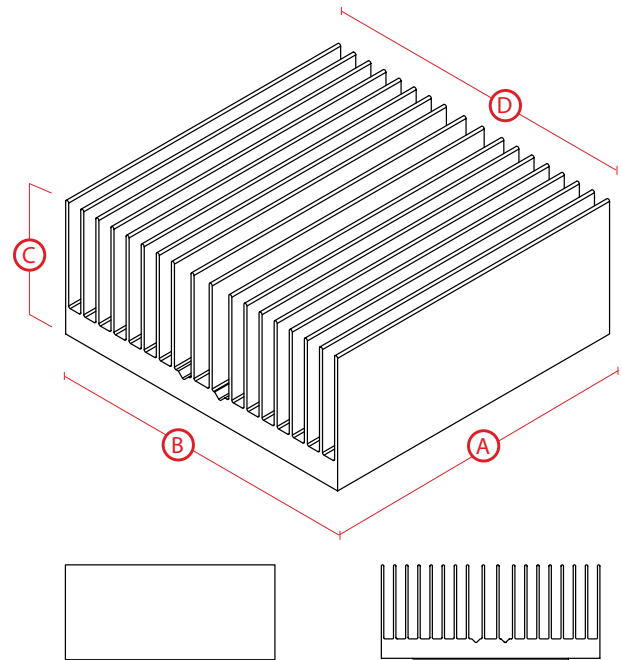

## Thermal Performance Table

AIR VELOCITY		THERMAL RESISTANCE	
FT/MIN	M/S	°C/W (UNDUCTED)	°C/W (DUCTED)
200	1.0	7.6	4.5
300	1.5	5.9	
400	2.0	5.1	
500	2.5	4.6	
600	3.0	4.2	
700	3.5	3.9	
800	4.0	3.7	

## Product Details†

DIMENSION A	DIMENSION B	DIMENSION C§	DIMENSION D	TIM‡	FINISH
27	27	14.5	N/A	C675	BLACK-ANODIZED

For further technical information, please contact Advanced Thermal Solutions, Inc. at **1-781-769-2800** or [www.qats.com](http://www.qats.com)

\* RoHS Compliant

‡ TIM = Thermal Interface Material

† Dimensions are measured in millimeters

◆ Dimensions A & B refer to component size

§ Dimension C = the height of the heat sink shown above and does not include the height of the attachment method



**ATS** ADVANCED THERMAL SOLUTIONS, INC.

Innovations in Thermal Management®



To place an order, please visit [www.digikey.com](http://www.digikey.com)